

MOD. VB270

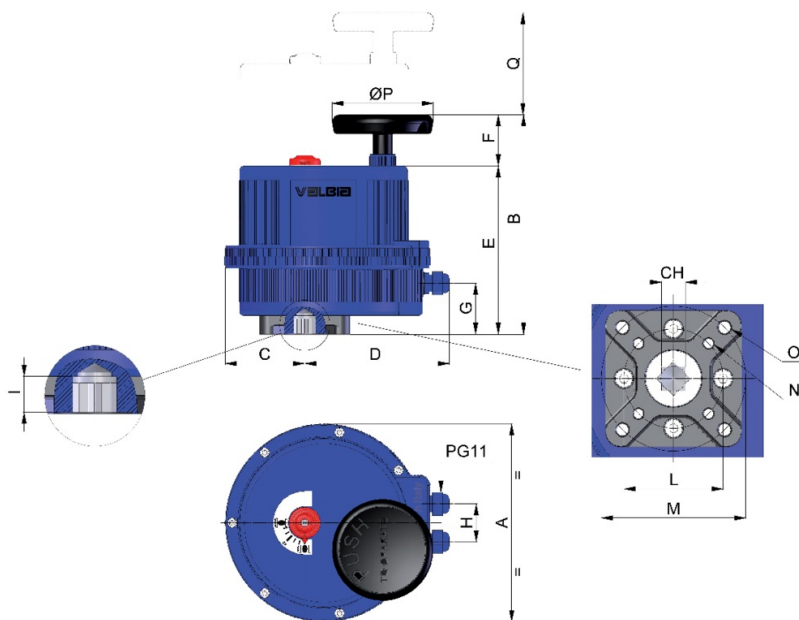

Spécifications techniques



MOD	FORATURA DRILLING ISO 5211	CH	A	B	C	D	E	F	G	H	I	L	M	N	O	ØP	Q
MOD. VB270	F07-F10	22	222	233,5	77	170	182	51,5	54	40	24	70	102	M8x20	M10x20	110	115

Applications



FOOD &
BEVERAGE



HVAC



PAINTS &
SOLVENTS



WATER
TREATMENT



CHEMICAL



OEM



POWER &
RENEWABLE
ENERGY