

## 8P027000

2 way Wafer ball valve [Valpres art. 720186] stainless steel AISI 304, Fire Safe, Antistatic Device, classified ATEX Ex II 2 G/D c T3.

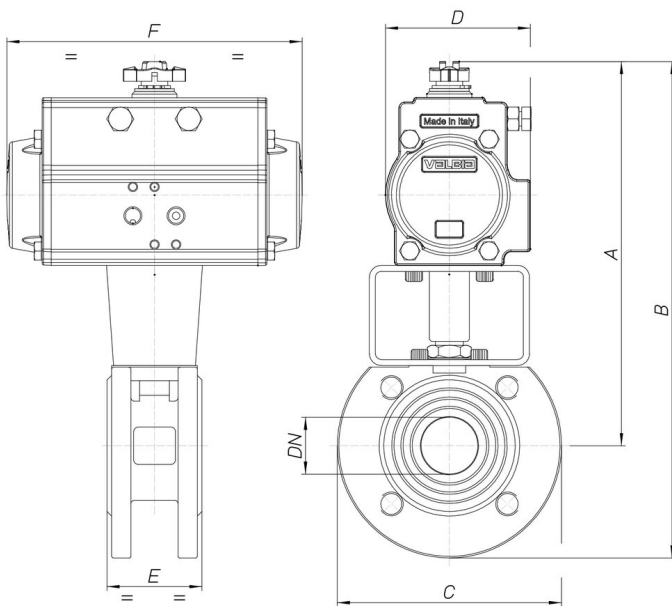

### Especificaciones técnicas



<b>MOD</b>	<b>PN</b>	<b>A</b>	<b>B</b>	<b>C</b>	<b>D</b>	<b>E</b>	<b>F</b>	<b>ACT.</b>	<b>RI</b>
8P02700004	16	183	228	90	71	35	141	SR52	3780
8P02700005	16	218	568	100	95	40	210	SR75	5349
8P02700006	16	225	283	115	95	46	210	SR75	3880
8P02700007	16	230	299	140	95	54	210	SR75	3881
8P02700008	16	272	347	150	123	64	275	SR100	3009
8P02700010	16	281	363	165	123	82	275	SR100	3009
8P02700012	16	364	457	185	148	103	372	SR125	3010
8P02700014	16	371	471	200	148	122	372	SR125	3010
8P02700018	16	410	520	220	164	152	435	SR140	3037
8P02700019	16	456	581	250	186	196	500	SR160	3037
8P02700020	16	513	656	285	213	232	493	SR180	3040