

8P020000

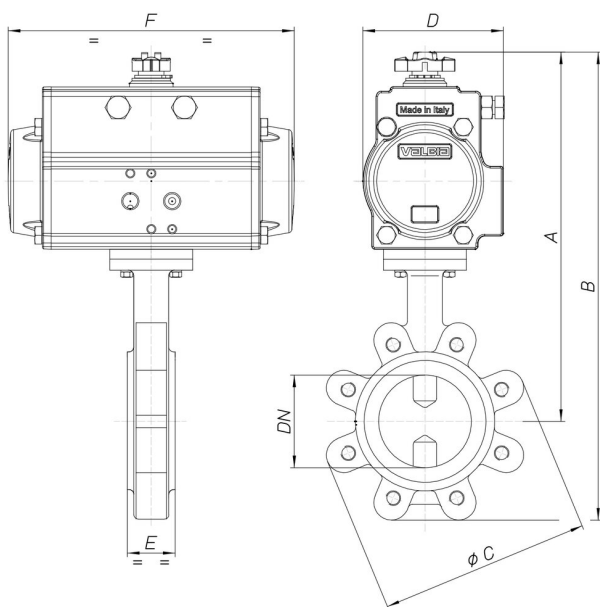

Butterfly valve Lug type PN16, (from DN40 to DN300)
 PN10 (from DN350 to DN600) body in cast iron
 GGG40+ epoxy painting, disc AISI 316, EPDM [Valpres
 art. 600205] or NBR [Valpres art. 600230] seat from
 DN40 to DN300, EPDM seat art. 905262 from DN350 to
 DN600.

Technical specifications



MOD	PN	A	B	Ø C	D	E	F	ACT.	RI
8P02000008	16	235	305	145	81	33	164	SR 63	3843
8P02000010	16	266	338	165	81	43	164	SR 63	3843
8P02000012	16	279	357	185	81	46	164	SR 63	3843
8P02000014	16	312	401	200	106	46	241	SR 85	3844
8P02000018	16	328	430	220	106	52	241	SR 85	3840
8P02000019	16	354	477	250	123	56	275	SR 100	3846
8P02000020	16	398	536	285	137	56	333	SR 115	4450
8P02000021	16	793	661	340	186	60	500	SR 160	3848
8P02000077	16	524	731	405	186	68	500	SR 160	3867
8P02000078	16	697	940	460	213	78	579	SR 200	3309