

## 8P025700

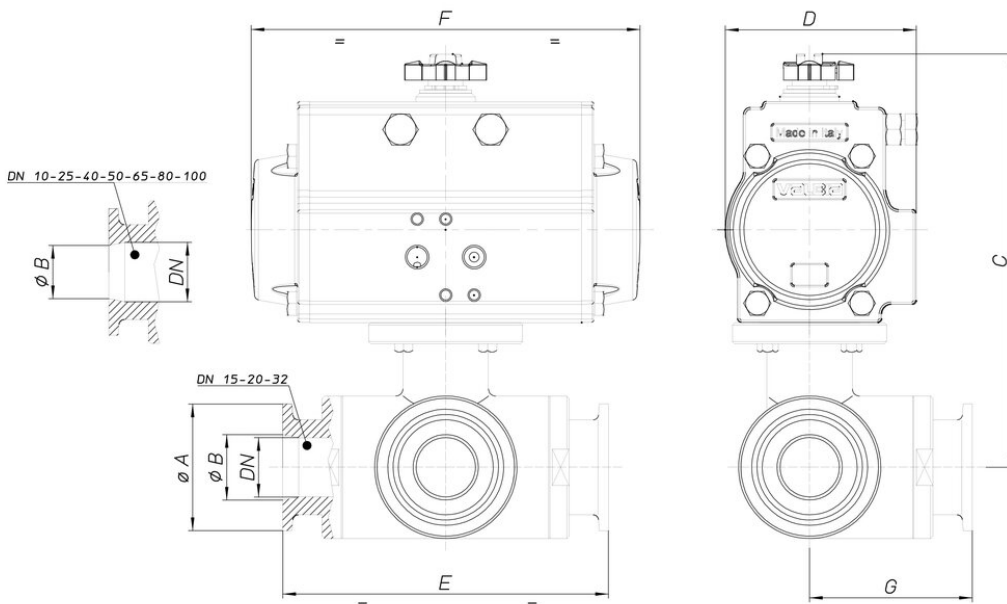

3 way ball valve, from ingot, AISI 316, clamp connections ISO 2852, DIN 32676 TABLE 4 REIHE C for tube BS/OD (ASTM A270), 4 P.T.F.E. seals, polished, full bore or reduced bore, "T" or "L" port.

### Technical specifications



<b>MOD</b>	<b>PN</b>	<b>ØA</b>	<b>ØB</b>	<b>C</b>	<b>D</b>	<b>E</b>	<b>F</b>	<b>G</b>	<b>ACT.</b>
8P02570003	40	25	9,7	210	81	108	164	54	SR 63
8P02570004	40	25	16	212	81	118	164	59	SR 63
8P02570005	40	51	22,2	202	106	130	241	65	SR 85
8P02570007	40	51	34,8	227	106	156	241	78	SR 85
8P02570010	25	64	47,5	250	123	182	275	91	SR 100
8P02570012	25	78	60,2	294	137	196	333	98	SR 115
8P02570014	16	91	72,6	321	148	256	372	128	SR 125
8P02570018	16	119	97,6	358	164	286	435	143	SR 140