

8P007100

3 way flanged polished ball valve from ingot, 4 seals, stainless steel AISI 316, FULL bore, "T" or "L" port, with actuator.

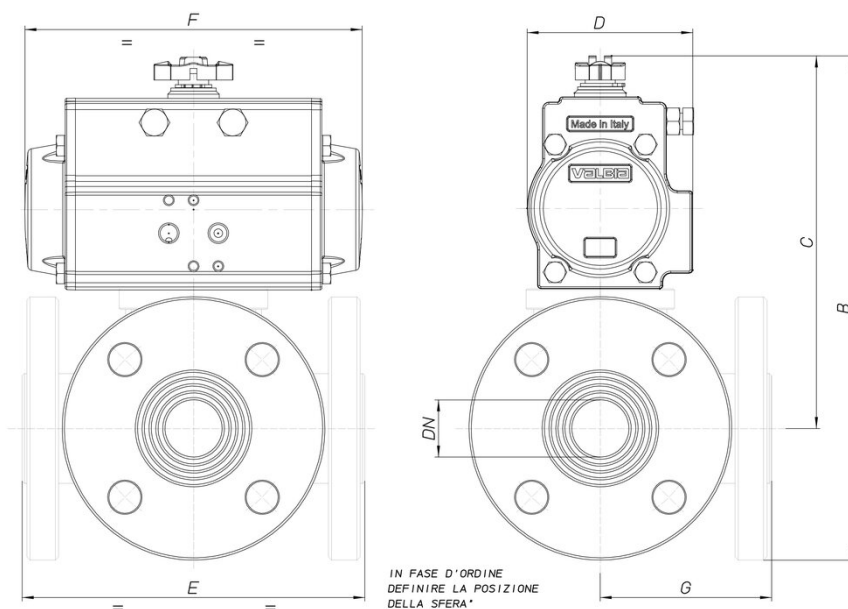

Technical specifications



MOD	PN	B	C	D	E	F	G	ACT.
8P00710003	40	193	148	71	120	141	60	DA 52
8P00710004	40	199	151	71	130	141	65	DA 52
8P00710005	40	223	170	81	140	164	70	DA 63
8P00710006	40	232	174	81	150	164	75	DA 63
8P00710007	40	265	195	81	180	164	90	DA 63
8P00710008	40	295	220	95	200	210	100	DA 75
8P00710010	25	320	237	106	220	241	110	DA 85
8P00710012	16	340	247	106	240	241	120	DA 85
8P00710014	16	374	274	123	260	275	130	DA 100
8P00710018	16	399	289	123	300	275	150	DA 100