

8P025100

3 ways ball valve, from ingot, 4 PTFE seals, AISI 316, polished, DIN 11851 connection F/F/F, full bore, T or L port, with actuator.

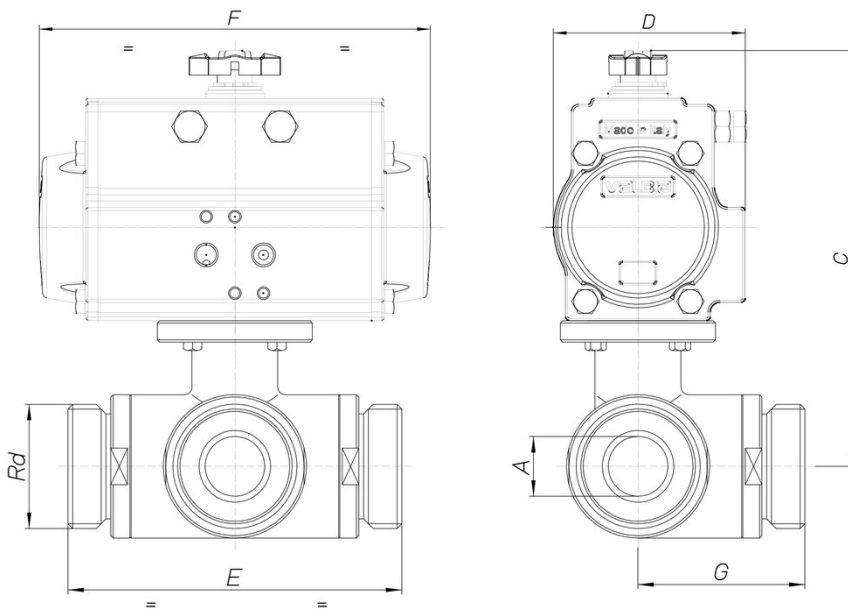

Technical specifications



MOD	PN	A	RD	C	D	E	F	G	ACT.
8P02510003	40	10	28x1/8"	148	71	108	141	54	DA 52
8P02510004	40	15	34x1/8"	151	71	118	141	59	DA 52
8P02510005	40	20	44x1/6"	170	81	130	164	65	DA 63
8P02510006	40	25	52x1/6"	174	81	140	164	70	DA 63
8P02510007	40	32	58x1/6"	195	81	156	164	78	DA 63
8P02510008	40	40	65x1/6"	220	95	172	210	86	DA 75
8P02510010	25	50	78x1/6"	237	106	182	241	91	DA 85
8P02510012	25	65	95x1/6"	247	106	196	241	98	DA 85
8P02510014	16	80	110x1/4"	274	123	256	275	128	DA 100
8P02510018	16	100	130x1/4"	289	123	286	275	143	DA 100