

## 8P008600

3-Wege-Kugelhahn [RB Art. 3500 (T) - 3600 (L)], aus Messing CW 617N, Dichtungen PTFE + VITON, Gewindeanschluß I/I/I, voller Durchgang, "T" oder "L" Bohrung, mit Antrieb. Nicht geeignet für Lösungsmittel.

### Technische Spezifikationen

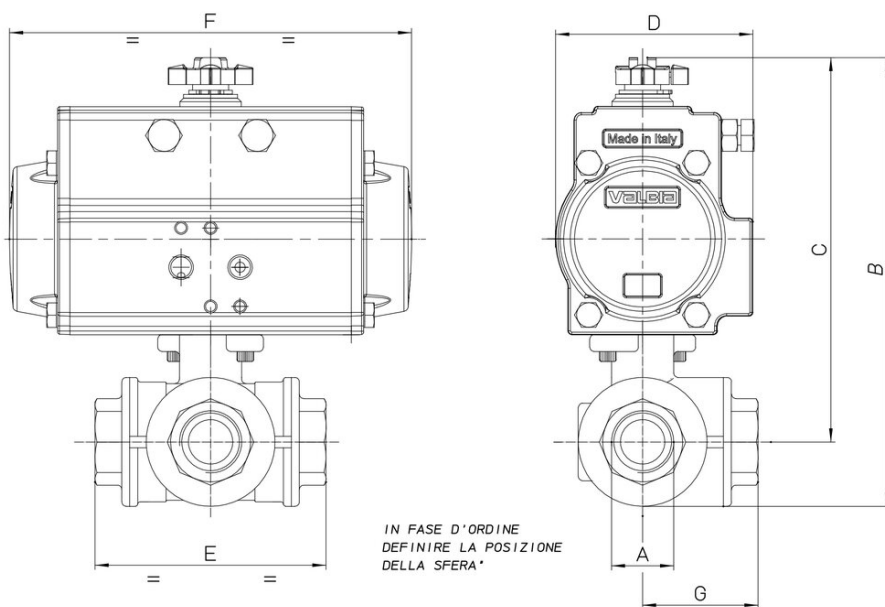

<b>MOD</b>	<b>PN</b>	<b>A</b>	<b>B</b>	<b>C</b>	<b>D</b>	<b>E</b>	<b>F</b>	<b>G</b>	<b>ACT.</b>	<b>RI</b>
8P00860002	30	1/4"	149	132	71	67	141	34	SR 52	3798
8P00860003	30	3/8"	149	132	71	67	141	34	SR 52	3798
8P00860004	30	1/2"	154	134	71	77	141	39	SR 52	3798
8P00860005	30	3/4"	179	155	81	87	164	44	SR 63	4025
8P00860006	16	1"	190	160	81	105	164	53	SR 63	4025
8P00860007	10	1"1/4	209	173	81	123	164	62	SR 63	4025
8P00860008	10	1"1/2	262	219	106	139	241	70	SR 85	4026
8P00860010	10	2"	299	243	123	166	275	83	SR 100	4026